

**Durable,
Long-lasting
Punches &
Punch Blanks**

TUFFPUNCH[®]



Global leader in quality
metal fabrication and stamping tools

www.daytonprogress.com

**Heads-
above-the-rest
performance**



TuffPunch® Heavy-Duty Punches and Punch Blanks

Product Applications

Dayton Progress **TuffPunch® Punches** and **Punch Blanks** are Kommercial quality products manufactured with thicker, larger, and 10° angled diameter heads, and are designed to reduce punch load and significantly lower failure rates when using heavy gauge and high tensile material. (See p. 3 for additional information.) TuffPunch® products are well-suited for high-demand industries where frequency and heavier-than-normal impact punching activity occurs and where optimum performance is required.

Dayton's TuffPunch® product line includes: **Dayton Jektol® Punches**; **Regular Punches**; and **Punch Blanks**. Both standard sizes and standard alterations are shown in this catalog.

Unique Head Design

All Dayton TuffPunch® products are designed with a 10° angled head with a diameter equal to the shank diameter (see photo). This design allows the perforating forces to travel up from the shank and completely through the head. This eliminates the lateral shock waves that would otherwise put stress on the outer edge of the head, resulting in frequent failures—especially in heavy-duty applications.

In addition, Dayton TuffPunch® products are available in *common shear angle configurations* to reduce punch load and minimize the risk of slug pulling. Shear angle configurations include: chamfer; conical; double shear; and single shear. For more information, see "Standard Alterations" on p. 6.

Cryogenic Treatment Standard

DayKool™ (XCR)—a cryogenic steel conditioning process used primarily with hard, thick materials to improve strength, toughness, and dimensional stability—is **standard** on all Dayton TuffPunch® products.

The **DayKool™** process utilizes a liquid nitrogen vapor to cool the steel to -300° F, which creates metallurgical



changes in the structure that disperse carbides throughout the metal. The result: increased wear resistance (finely dispersed carbides provide more evenly distributed wear); less sharpening time; no loss of resistance after sharpening; longer die runs; and less downtime.

Surface Treatments

All products listed in this catalog can be treated to increase material hardness, reduce galling, and improve wear/and or corrosion resistance. A surface treatment chart is included on each product page.

DayTride® (XN)—a low-cost surface application that treats all exposed surfaces. Ideal for punches and matrixes. Provides high dimensional stability. Apprx. Hardness: RC73.

DAYTiN® (XNT)—applied via PVD (physical vapor deposition). Provides extreme hardness (hard as carbide) and excellent lubricity when used with a lubricant. Not recommended for stainless steel, copper, or nickel. Apprx. Hardness: *Vickers 2300.

TiCN (XCN)—very hard PVD, thin film. Provides ultra hardness (harder than carbide) and superior abrasive wear resistance. Apprx. Hardness: *Vickers 3000.

The Dayton Difference



Since 1946, *innovation* has been the key at Dayton Progress to bringing leading-edge products to the marketplace. Dayton has developed hundreds of proprietary, value-added metal stamping and fabricating tools, and we hold numerous international patents and trademarks.

Today, Dayton designers, engineers, and product managers continue this long-standing tradition by developing, manufacturing, and supplying *innovative* application-specific products for thousands of customers around the world.

*Vickers used when RC exceeds 80.

TuffPunch®, DayKool™, DayTride®, and DAYTiN® are trademarks of Dayton Progress Corporation.

©2003 Dayton Progress Corporation. All rights reserved.

Ordering Information

Each page contains detailed instructions on how to order specific Dayton TuffPunch® products. Individual drawings show product shape, dimensions, tolerances, and concentricity. When ordering, you are asked to specify quantity, type, shank and length codes (for example), and other applicable data.

HOW TO ORDER

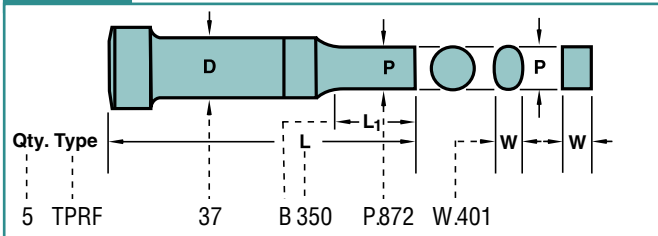

In the example above, the type specified is “TPRF.” “T” stands for TuffPunch®, “P” stands for punch, and “R” stands for rectangle. “F” is an additional product code. 37 is the press-fit diameter, which is coded by the first two digits of the decimal equivalent (.375). B350 stands for the point and overall length with the “B” as the code for .75" point length and 350 as the code for punch length in inches (three and one-half inches). Finally, P.872 and W.401 represent the point or hole size dimensions.

Standard Alterations

Punches and punch blanks are available in sizes other than those listed in the catalog. These special order products can be manufactured for a slight additional charge. Unless otherwise noted, there is no additional delivery charge.

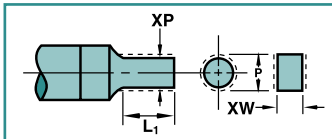

When ordering, you are asked to specify different designations for various non-standard dimensions.

For example, if the P & W dimensions are smaller than standard, an “X” must be placed in front of the P or W dimensions, e.g., “XP” and “XW.” If the point length is longer than standard, designate “XBR(L₁)” for the point length. The sample drawing above is from the “Standard Alterations” section on p. 6.

Other special order designations include: “XBR” for straight before radius; “XL” for overall length shortened; “XK” for no side hole and no components (for air ejection of slugs); and special designations for surface treatments and coatings.

Product Designation

When ordering, you are asked to specify quantity, product type, length codes, and point or hole size (for example). In addition, use the following chart to define the product as a part number.

Description			
TPRF	Line	T for TuffPunch®	
	Product	P for Punch (Regular)	
	Shape	R for Rectangle	
		F is additional product code	
	75	Press-Fit Dia. D (shank diameter)	
		Coded by the first 2 digits of decimal equivalent (.750).	
	L₁	Point Length	
		350	Overall Length L
			Coded by whole number and first two digits of decimal equivalent (3.500).
Product	Series	Length	Point or Hole Size
TPRF	75	B 350	P.872, W.401
Type	Catalog Number		Dimensions As Specified

Diameter (D) is shown on the order as a two-digit code. To convert the shank diameter to the appropriate code, use the following chart.

Code	D	Code	D
37	.3750	75	.7500
43	.4375	87	.8750
50	.5000	100	1.0000
62	.6250		

Special Features

There are several features that contribute to minimize failures. In addition to the head design and large fillet (.040"-.060" radius) under the head, all punch shapes with sharp corners will have a carefully blended .005" radius ground to reduce loading on the punch. The reduced load and standard cryogenic treatment result in fewer punch point problems caused by chipping, wear, or breakage.

TuffPunch® Jektole® Punches

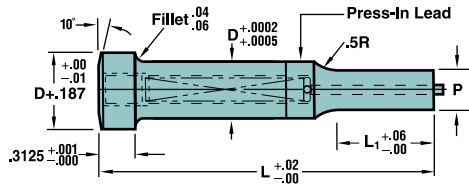
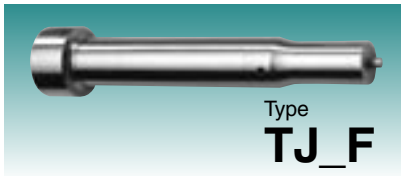

HOW TO ORDER

Specify: Qty. Type D Code L P (or P&W) Dimension
 Example: 6 TJXF 37 C225 P.204

Note: The standard location of a key flat is parallel to the P dimension. For additional information, see p.7.

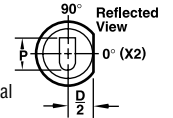

Material

Steel: PS4 (CPM M4), RC 60-62
 Heads RC 40-55

Round P $\pm .0005$ to $-.0000$ $\odot .0005$ P to D
 Shape P, W $\pm .0005$ $\odot .001$ P to D

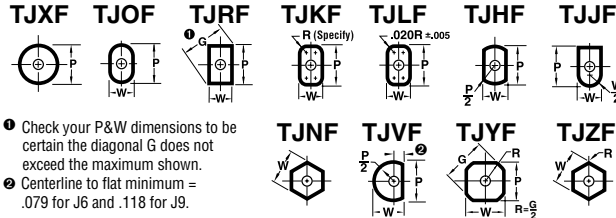

- 1 Check your P&W dimensions to be certain the diagonal G does not exceed the maximum shown.
- 2 Centerline to flat minimum = .079 for J6 and .118 for J9.

Standard shapes with sharp corners will have a .005" radius to reduce loading on the punch.

Standard Alterations

See p.6 for additional ordering instructions.



Shank D	Code	Point Length L ₁			Round		Shape		L											Jektole® Group		
		A	B	C	Min. XP	Range P	Min. XW	Min. Max. W P/G	2.00	2.25	2.50	2.75	3.00	3.25	3.50	3.75	4.00	4.25	4.50		4.75	5.00
.3750	37	.50	.75	1.00	.158	.158 - .3749	.158	.158 - .375	200	225	250	275	300	325	350	375	400	425	450	475	500	J6
.4375	43	.50	.75	1.00	.158	.187 - .4374	.158	.187 - .4375	200	225	250	275	300	325	350	375	400	425	450	475	500	J6
.5000	50	.50	.75	1.00	.158	.250 - .4999	.158	.187 - .500	200	225	250	275	300	325	350	375	400	425	450	475	500	J6
.6250	62	.50	.75	1.00	.235	.375 - .6249	.235	.250 - .625	200	225	250	275	300	325	350	375	400	425	450	475	500	J9
.7500	75	.50	.75	1.00	.300	.500 - .7499	.235	.312 - .750	200	225	250	275	300	325	350	375	400	425	450	475	500	J9
.8750	87	.50	.75	1.00	.400	.562 - .8749	.235	.312 - .875	200	225	250	275	300	325	350	375	400	425	450	475	500	J9
1.0000	100	.50	.75	1.00	.400	.625 - .9999	.235	.375 - 1.000	200	225	250	275	300	325	350	375	400	425	450	475	500	J9

Note: DayKool™ (XCR)—a cryogenic steel conditioning process used primarily with hard, thick materials to improve strength, toughness, and dimensional stability—is standard on all Dayton TuffPunch® products. For additional information, see p.2.

Surface Treatments

See p.2 for details.

Code/Added Delivery	
XCN —TiCN	+4 days
XN —DayTride®	+3 days
XNT —DayTiN®	+4 days

TuffPunch® Jektole® Punch Blanks

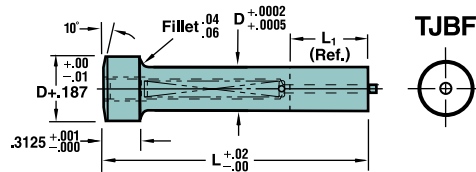
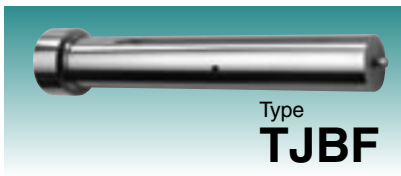

HOW TO ORDER

Specify: Qty. Type D Code L
 Example: 9 TJBF 37 B200

Standard Alterations

See p.6 for additional ordering instructions.

Material
 Steel: PS4 (CPM M4), RC 60-62
 Heads RC 40-55

Shank D	Code	Point Length L ₁			L											Jektole® Group		
		A	B	C	2.00	2.25	2.50	2.75	3.00	3.25	3.50	3.75	4.00	4.25	4.50		4.75	5.00
.3750	37	.50	.75	1.00	200	225	250	275	300	325	350	375	400	425	450	475	500	J6
.4375	43	.50	.75	1.00	200	225	250	275	300	325	350	375	400	425	450	475	500	J6
.5000	50	.50	.75	1.00	200	225	250	275	300	325	350	375	400	425	450	475	500	J6
.6250	62	.50	.75	1.00	200	225	250	275	300	325	350	375	400	425	450	475	500	J9
.7500	75	.50	.75	1.00	200	225	250	275	300	325	350	375	400	425	450	475	500	J9
.8750	87	.50	.75	1.00	200	225	250	275	300	325	350	375	400	425	450	475	500	J9
1.0000	100	.50	.75	1.00	200	225	250	275	300	325	350	375	400	425	450	475	500	J9

Note: DayKool™ (XCR)—a cryogenic steel conditioning process used primarily with hard, thick materials to improve strength, toughness, and dimensional stability—is standard on all Dayton TuffPunch® products. For additional information, see p.2.



Surface Treatments

See p.2 for details.

Code/Added Delivery	
XCN —TiCN	+4 days
XN —DayTride®	+3 days
XNT —DayTiN®	+4 days

TuffPunch® Regular Punches

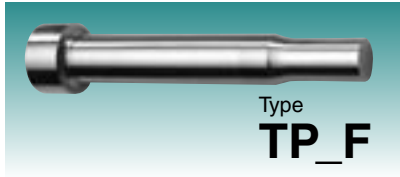

Type
TP_F

Material

Steel: PS4 (CPM M4), RC 60-62
Heads RC 40-55

Round P $\begin{matrix} +.0005 \\ -.0000 \end{matrix}$ $\begin{matrix} \text{C} \\ \text{C} \end{matrix}$.0005 P to D
Shape P,W $\pm .0005$ $\begin{matrix} \text{C} \\ \text{C} \end{matrix}$.001 P to D

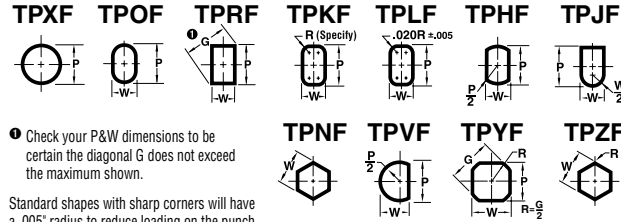
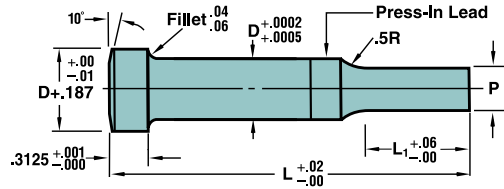

Check your P&W dimensions to be certain the diagonal G does not exceed the maximum shown.

Standard shapes with sharp corners will have a .005" radius to reduce loading on the punch.

HOW TO ORDER

Specify: Qty. Type D Code L P (or P&W) Dimension
Example: 9 TPLF 100 B350 P.872, W.401

Note: The standard location of a key flat is parallel to the P dimension. For additional information, see p.7.

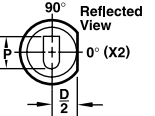

Standard Alterations
See p.6 for additional ordering instructions.

Shank D	Code	Point Length L ₁			Round		Shape		L												
		A	B	C	Min. XP	Range P	Min. XW	Min. Max. W P/G	2.00	2.25	2.50	2.75	3.00	3.25	3.50	3.75	4.00	4.25	4.50	4.75	5.00
.3750	37	.50	.75	1.00	.062	.158 - .3749	.109	.158 - .375	200	225	250	275	300	325	350	375	400	425	450	475	500
					.093	.158 - .3749	.125	.158 - .375													
.4375	43	.50	.75	1.00	.080	.187 - .4374	.109	.187 - .4375	200	225	250	275	300	325	350	375	400	425	450	475	500
					.109	.187 - .4374	.125	.187 - .4375													
.5000	50	.50	.75	1.00	.125	.250 - .4999	.125	.187 - .500	200	225	250	275	300	325	350	375	400	425	450	475	500
					.125	.250 - .4999	.141	.187 - .500													
.6250	62	.50	.75	1.00	.235	.375 - .6249	.235	.250 - .625	200	225	250	275	300	325	350	375	400	425	450	475	500
					.235	.375 - .6249	.235	.250 - .625													
.7500	75	.50	.75	1.00	.300	.500 - .7499	.235	.312 - .750	200	225	250	275	300	325	350	375	400	425	450	475	500
					.300	.500 - .7499	.235	.312 - .750													
.8750	87	.50	.75	1.00	.350	.562 - .8749	.235	.312 - .875	200	225	250	275	300	325	350	375	400	425	450	475	500
					.350	.562 - .8749	.235	.312 - .875													
1.0000	100	.50	.75	1.00	.400	.625 - .9999	.235	.375 - 1.000	200	225	250	275	300	325	350	375	400	425	450	475	500
					.400	.625 - .9999	.235	.375 - 1.000													

Note: DayKool™ (XCR)—a cryogenic steel conditioning process used primarily with hard, thick materials to improve strength, toughness, and dimensional stability—is standard on all Dayton TuffPunch® products. For additional information, see p. 2.



Surface Treatments
See p.2 for details.

Code/Added Delivery	
XCN —TiCN	+4 days
XN —DayTride®	+3 days
XNT —DayTiN®	+4 days

TuffPunch® Regular Punch Blanks

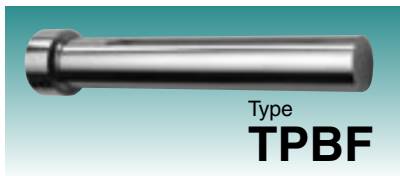

Type
TPBF

Material

Steel: PS4 (CPM M4), RC 60-62,
Heads RC 40-55

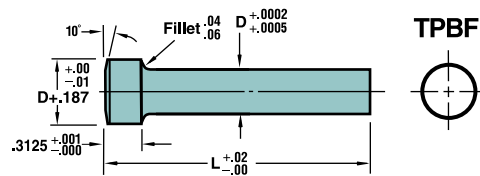

TPBF

HOW TO ORDER

Specify: Qty. Type D Code L
Example: 9 TPBF 37 200

Standard Alterations
See p.6 for additional ordering instructions.

Shank D	Code	L												
		2.00	2.25	2.50	2.75	3.00	3.25	3.50	3.75	4.00	4.25	4.50	4.75	5.00
.3750	37													
.4375	43													
.5000	50													
.6250	62	200	225	250	275	300	325	350	375	400	425	450	475	500
.7500	75													
.8750	87													
1.0000	100													

Note: DayKool™ (XCR)—a cryogenic steel conditioning process used primarily with hard, thick materials to improve strength, toughness, and dimensional stability—is standard on all Dayton TuffPunch® products. For additional information, see p. 2.



Surface Treatments
See p.2 for details.

Code/Added Delivery	
XCN —TiCN	+4 days
XN —DayTride®	+3 days
XNT —DayTiN®	+4 days

Standard Alterations—Punches and Punch Blanks

Standard Alterations

Punches are available in sizes other than those listed in the front of the catalog.

Jektole[®], Regular, and Punch Blanks

XP, XW P & W Dimensions Smaller than Standard

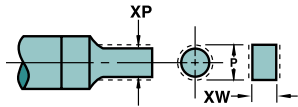

XBR (Straight Before Radius) It is recommended that point lengths be kept as short as possible for optimum strength.

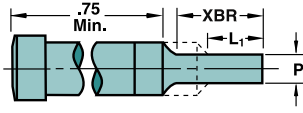

L ₁ Max.		.500	.750	1.000	1.250	.500	.750	1.000	1.250	Jektole [®] Group
Code	Type	Min. P (Rounds)				Min. W (Shapes)				
37	*TJ	.158	.158	.158	.158	.158	.158	.172	.195	J6
	TP	.062	.093	.125	.156	.109	.125	.125	.195	
43	*TJ	.158	.158	.158	.158	.158	.158	.172	.195	J6
	TP	.080	.109	.125	.156	.109	.125	.172	.195	
50	*TJ	.158	.158	.158	.158	.158	.158	.172	.195	J6
	TP	.125	.125	.125	.156	.125	.141	.172	.195	
62	TJ	.235	.235	.235	.235	.235	.235	.235	.235	J9
	TP	.235	.235	.235	.235	.235	.235	.235	.235	
75	TJ	.300	.300	.300	.300	.235	.235	.235	.235	J9
	TP	.300	.300	.300	.300	.235	.235	.235	.235	
87	TJ	.350	.350	.350	.350	.235	.235	.235	.235	J9
	TP	.350	.350	.350	.350	.235	.235	.235	.235	
100	TJ	.400	.400	.400	.400	.235	.235	.235	.235	J9
	TP	.400	.400	.400	.400	.235	.235	.235	.235	

*Specify XP or XW and XJ for TJ products.

The smaller minimum dimensions shown next to TP can be used.

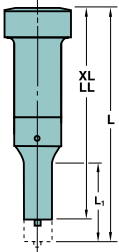

XL Overall Length Shortened (1.00 min.)
Stock removal from point end which shortens B length.

LL Precision Overall Length
Same as XL except overall length is held to $\pm .001$.

XK No Side Hole
For air ejection. No cost.

XS Shear Angles
See information at right.

XJ Smaller Jektole Components

Note: For surface treatment information, see p. 2 and individual product pages.

Shear Angles (XS)

TuffPunch[®] products are available in *common shear angle configurations* for all standard shapes. Shear angles are also available for classified shapes as special orders.

Shear angles are available in any angle. Specify angle in whole degrees. If half degree is necessary, specify as a decimal, e.g., 8.5°. (Tolerance on all angles is ± 15 minutes.) Use the chart below to determine the product designation, then simply add the alteration code shown next to the drawings, along with the angle desired. Example: TPXF 50, C300, P.400, XS20, A5°.

For Round Punches Only

Views are reflected view.

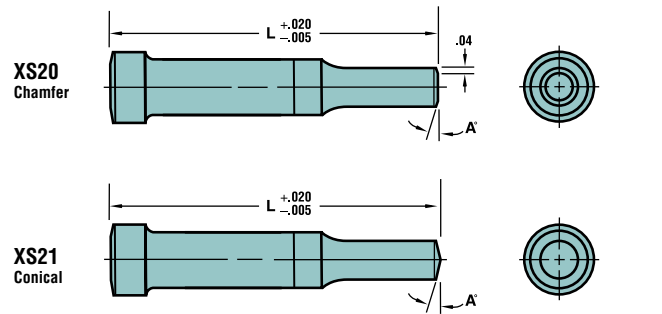

For Round and Shape Punches

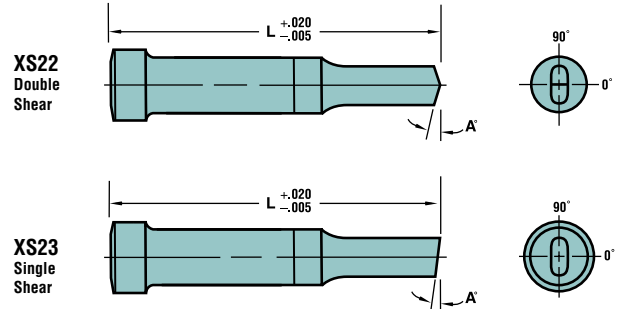

Locking Devices—Flats vs. Dowel Slots

Orientation

The standard location for all locking devices is 0°, and is always on the long side (P) of the shape. Custom locations are measured counterclockwise from 0°.

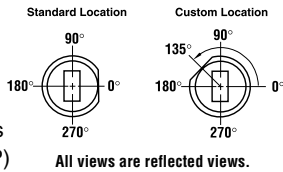

Standard and Alternate Locations

Definitions: **Standard Location** is at 0°. **Alternate Location** is 90°, 180°, or 270°.

Alternate locations are available at no additional charge.

Custom Locations

Definitions:

Custom Location is *any angle other than*: 0°, 90°, 180°, or 270°.

Single Flats

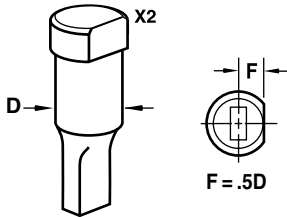

Single Flats: X2

Order Example: X2 — 90°

Single Flats: X5

Order Example: X5 — 135°

Double Flats

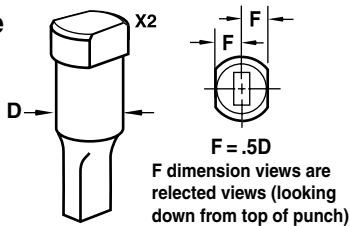

Double Flats: X3

Locking Devices: X3

Order Example: X3 — 90°

Second Flat is *always parallel* to the first flat.

Double Flats: X6

Locking Devices: X6

Order Example: X6 — 135°

Additional Flats



The depth of the flat is taken from the shank, not the head, on punches.

Additional Flats

Code	Depth	Length
X81	.060	.500
X82	.060	.625
X83	.060	.750
X84	.060	Full Length
X85	.093	.500
X86	.093	.625
X87	.093	.750
X88	.093	Full Length
X89	Specify Dimensions	

Additional Flats

Code	Depth	Length
X91	.060	.500
X92	.060	.625
X93	.060	.750
X94	.060	Full Length
X95	.093	.500
X96	.093	.625
X97	.093	.750
X98	.093	Full Length
X99	Specify Dimensions	

Dowel Slots

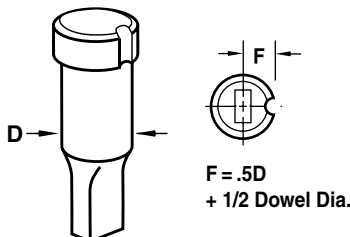

Dowel Slots: X4 & X41

For standard locations, specify **X4** (.125 Dowel) or **X41** (.1875 Dowel). For alternate locations, specify **X4** or **X41** and degree required.

Order Example: X4 — 90°

Dowel Slots: X7 & X71

Specify **X7** (.125 Dowel) or **X71** (.1875 Dowel). For custom locations, specify **X7** or **X71** and degree required.

Order Example: X71 — 135°

Location Tolerance

Flat		Dowel	
F	Radial	F	Radial
+ .0005	.001/ inch	+ .0005	0°4'
- .0000		- .0000	

How To Specify

The most common locking devices—flat, double flat, and dowel—are available. Simply select the type, then add the code to the component description.

HOW TO ORDER

Specify:	Qty.	Type	D Code	P (or P&W) Dimension	Locking Device
Example:	1	TJRF	37	P.321, W.189	X2

DAYTON PROGRESS CORPORATION

500 Progress Road
P.O. Box 39
Dayton, Ohio 45449-0039 USA
Telephone: (937) 859-5111
Fax: (937) 859-5353

Dayton Progress Canada, Ltd.
861 Rowntree Dairy Road
Woodbridge, Ontario L4L 5W3
Telephone: (905) 264-2445
Fax: (905) 264-1071

Dayton Progress Ltd.
G1 Holly Farm Business Park
Honiley, Kenilworth
Warwickshire CV8 1NP UK
Telephone: 44 1 926 484192
Fax: 44 1 926 484172

Dayton Progress Corporation of Japan
2-7-35 Hashimotodai
Sagamihara-Shi, Kanagawa-Ken
229-1132 Japan
Telephone: 81 427 74 0821
Fax: 81 427 73 4955

Dayton Progress GmbH
Im Heidegraben 8
Postfach 1165
61401 Oberursel/Ts., Germany
Telephone: 49 61 71 924201
Fax: 49 61 71 924220

Dayton Progress SAS
105 Avenue de l'Épinette
BP 128
Zone Industrielle
77107 Meaux Cedex
France
Telephone: 33 1 60 247301
Fax: 33 1 60 247300



Global leader in quality metal fabrication and stamping tools